



Opens the future

AUTOMATIC DOORS '08

RANGE AND ACCESSORIES CATALOGUE - SELECTION GUIDE

Automatic doors

Radars IR sensors

Selectors

Control systems

Accessories

BFT. SAFE AND RELIABLE SOLUTIONS ANY TIME, ANYWHERE

2



Our Schio premises in Italy's Northeast stretch over 21,000 square metres, which include 15,000 sq m of indoor floor space. It is a modern facility that has recently been extended with the addition of two new buildings. Getting here is easy. From Verona's "Catullo" airport or Venice's "Marco Polo" airport or from the Milan/Venice A4 motorway: take the A31-Valdastico road, following the signs for Pivene Rocchette. Take the Schio/Thiene exit and follow the signs for Schio's northern industrial estate "Zona Industriale. BFT have always believed in service as a key element in their dealings with customers. A widespread network of installers and professionals work nationwide and across the globe to promptly solve technical and business issues of any kind. The quality of each product is guaranteed by an exclusive warranty formula that covers the purchase for 24 months. Giving you lasting peace of mind for years to come.

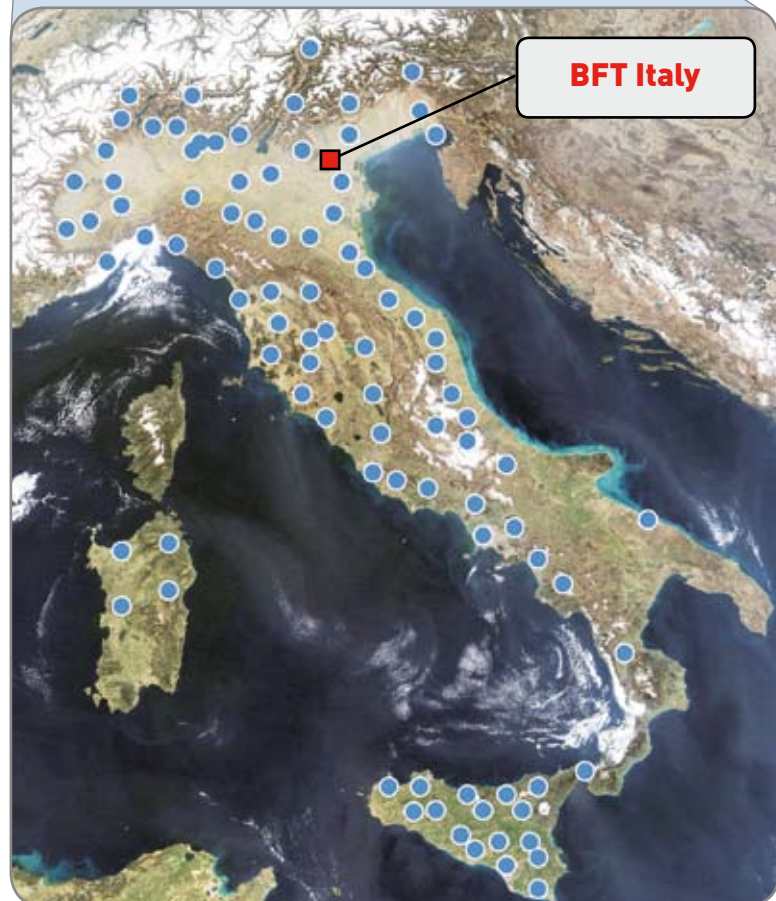

COMPANY CERTIFICATION



UNI EN ISO 9001-2000

Hinged on customer satisfaction, it specifies the total quality requirements of a company management system, with the aim of achieving better internal organization and improving relationships with stakeholders outside the company, with a focus on ensuring ISO 14001 customers receive increasingly efficient services.

BFT SpA's Environmental Management System was certified according to the standard UNI EN ISO 14001:1996 on 30/12/2003. BFT was awarded this company certification as a guarantee of its commitment to the environmental protection that always goes hand in hand with the development of a great company..



PRODUCT CERTIFICATIONS



CE

Compulsory European product self-certification that guarantees conformity with safety standard requirements



CSA

This certification guarantees product quality in compliance with certain standards that must be met for exports to be accepted into the North American market



Opens the future



• **POWER AND RELIABILITY**

Suitable for use on doors weighing up to 150kg (120+120kg in the case of 2-leaf models) used for continuous duty

• **RELIABLE OPERATION**

Electronic torque, speed and slow-down management system. Technologically advanced, it enables fast, accurate and harmonious motion, producing an unbeatably reliable installation.

• **SPEED OF INSTALLATION**

Designed to assure shorter installation times, it features simple, innovative solutions to make sure the installation stage is entirely effortless. These include the WWP installation profile, which means less people are required to do the job

(installation can be carried out even by one person on their own!) and the AUTOSET system via which all parameters required for operation can be set automatically.

• **WHISPER-QUIET OPERATION GUARANTEED TO LAST**

The aluminium track ensures that the sliding system will continue to provide peak mechanical performance well into the future. The shock-absorbing profile minimizes the amount of vibration transmitted to the structure, practically eliminating noise in the process.

• **INTUITIVE USE**

Designed with the installer in mind, it features simple, intuitive adjustment devices that are easy to reach. At the same time, it provides unbeatable ease of use for the end user who - through the VISTA SEL selector - can configure the door by simply pressing a key, with no chance of making a mistake

• **ELEGANCE AND FUNCTION**

Smooth lines and small size are two of the distinguishing traits of the VISTA SEL automatic door.

• **BUILT-IN RADIO-RECEIVER**

With a CLONIX-series 433Mhz radio-receiver built in as standard, the door can be controlled with the T BOX numerical keypad, wall and/or desktop RB button or MITTO remote controls.



VISTA SEL
Mode selector with option of restricted personnel access. A magnetic key can actually be used to lock out or enable its use.

TECHNICAL FEATURES

GENERIC FEATURES

SPECIFIC FEATURES

		VISTA SL1	VISTA SL2
POWER SUPPLY	230V 50Hz		
POWER INPUT	230 W		
OPERATING CYCLE	Continuous		
MINIMUM OPENING WIDTH		75 cm	80 cm
MAXIMUM OPENING WIDTH		255 cm	290 cm
MAXIMUM LEAF WEIGHT		150 kg	120+120 kg
MAXIMUM SPEED OF MOVEMENT		50 cm/sec	100 cm/sec
HEADER SIZE	166x155 mm		
PARTIAL OPENING	10-70% opening width		
ANTI-CRUSH	encoder and microprocessor		
OPERATING TEMPERATURE RANGE	0°/55°C inside enclosure		
RUNNER HEIGHT ADJUSTMENT	Up to 16 mm		



AUTOMATIC ADJUSTMENTS

- Acceleration
- Brake
- Opening deceleration distance
- Closing deceleration distance
- Opening slow-down distance
- Closing slow-down distance
- Opening speed
- Closing speed
- Opening torque
- Closing torque
- Safety operation testing

ADJUSTABLE FUNCTIONS

- Automatic closing (0-60 sec)
- Time-to-clear (1-99 sec)
- Partial opening (10-70%)
- Partial lock opening (3-30 cm)
- Alarm time (1-90 sec)
- Acceleration (1-10)
- Brake (1-10)
- Opening deceleration distance (10-70 cm)
- Closing deceleration distance (10-70 cm)
- Opening slow-down distance (10-20 cm)
- Closing slow-down distance (10-20 cm)
- Opening speed (1-99%)
- Closing speed (1-99%)
- Opening torque (1-99%)
- Closing torque (1-99%)
- Zones (0-127)
- Door mode (0-6)
- Radar enabling (0-2)
- Emergency input (0-3)
- Buzzer (0-3)
- Door output (0-1)
- Lock type (0-5)

VISTA SEL SELECTOR FUNCTIONS

- Programming unrestricted or protected by magnetic key
- Activate internal radar
- Activate external radar
- Activate internal and external radars
- Deactivate radar
- Normal mode
- Door closed at night
- Door closed by day
- Total opening
- Partial opening
- Partial open
- Partial lock opening

ELECTRIC LOCK MODE

- Motor always locked
- Motor locked with door closed only
- Motor locked every time stops
- Motor locked every time stops for more than 20 seconds
- Motor reacts with 10N to attempted opening
- Motor reacts with maximum force to attempted opening

ALARM CONFIGURATION

EMERGENCY INPUT

- Opens and locks the door if NO
- Closes and locks the door if NO
- Opens and locks the door if NC
- Closes and locks the door if NC

DOOR STATE OUTPUT

- Output active if door is not completely closed
- Output active if door is not completely open

ALARM OUTPUT

- Photocell triggered for longer than T.Alarm time
- Obstacle detected
- Attempt to force open closed door

COMPONENTS AND ACCESSORIES

VISTA SEL - D113722
Mode selector



PROXIMA - P111326
programmer



BBV - P111442
Emergency batteries

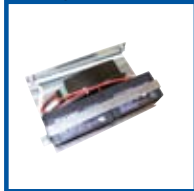

Mains supply
transformer



T-BOX - P121019
Wireless numerical keypad



24Vdc gearbox



VISTA ELA - N733415
Kit with elastic for
emergency open



Track vibration damper
profile



Belt adjustment
system



RB - P121016
Wireless wall button



Service and power
cable guide system



WMP
Mounting profile

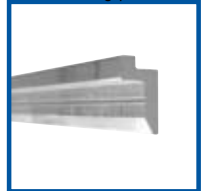

ERV - N733408
Electric lock

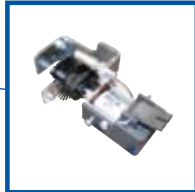

ARIA
Control unit



COMPASS RING - D110914
Proximity keyring



COMPASS SLIM - D113704
Proximity reader



DOORS AND COVERS RANGE

CODE	DESCRIPTION	POWER SUPPLY	B(mm)	A(mm)	L(mm)	ANODIZED CARTER
VISTA 1 - LEFT						
P960502 00002	VISTA SL-107	24 V	750	800	1600	P111411 00002
P960503 00002	VISTA SL-108	24 V	850	900	1800	P111412 00002
P960504 00002	VISTA SL-109	24 V	950	1000	2000	P111414 00002
P960505 00002	VISTA SL-110	24 V	1050	1100	2200	P111415 00002
P960506 00002	VISTA SL-111	24 V	1150	1200	2400	P111416 00002
P960507 00002	VISTA SL-112	24 V	1250	1300	2600	P111417 00002
P960508 00002	VISTA SL-113	24 V	1350	1400	2800	P111418 00002
P960509 00002	VISTA SL-114	24 V	1450	1500	3000	P111419 00002
P960510 00002	VISTA SL-115	24 V	1550	1600	3200	P111420 00002
P960511 00002	VISTA SL-116	24 V	1650	1700	3400	P111421 00002
P960512 00002	VISTA SL-117	24 V	1750	1800	3600	P111422 00002
P960513 00002	VISTA SL-119	24 V	1950	2000	4000	P111423 00002
P960514 00002	VISTA SL-121	24 V	2150	2200	4400	P111424 00002
P960515 00002	VISTA SL-123	24 V	2350	2400	4800	P111425 00002
P960516 00002	VISTA SL-125	24 V	2550	2600	5200	P111426 00002
VISTA 2						
P960517 00002	VISTA SL-208	24 V	800	2X500	1900	P111413 00002
P960518 00002	VISTA SL-209	24 V	900	2X500	2000	P111414 00002
P960519 00002	VISTA SL-210	24 V	1000	2X550	2200	P111415 00002
P960520 00002	VISTA SL-211	24 V	1100	2X600	2400	P111416 00002
P960521 00002	VISTA SL-212	24 V	1200	2X650	2600	P111417 00002
P960522 00002	VISTA SL-213	24 V	1300	2X700	2800	P111418 00002
P960501 00002	VISTA SL-214	24 V	1400	2X750	3000	P111419 00002
P960523 00002	VISTA SL-215	24 V	1500	2X800	3200	P111420 00002
P960524 00002	VISTA SL-216	24 V	1600	2X850	3400	P111421 00002
P960525 00002	VISTA SL-217	24 V	1700	2X900	3600	P111422 00002
P960526 00002	VISTA SL-219	24 V	1900	2X1000	4000	P111423 00002
P960527 00002	VISTA SL-221	24 V	2100	2X1100	4400	P111424 00002
P960528 00002	VISTA SL-223	24 V	2300	2X1200	4800	P111425 00002
P960529 00002	VISTA SL-225	24 V	2500	2X1300	5200	P111426 00002
P960530 00002	VISTA SL-227	24 V	2700	2X1400	5600	P111427 00002
P960531 00002	VISTA SL-229	24 V	2900	2X1500	6000	P111428 00002

NOTE:

- for natural aluminium guards, give the anodised guard codes with 00001 instead of 00002.
- for right side version give the left side codes with 00004 instead 00002

ACCESSORIES RANGE

CODE	DESCRIPTION
N733408	ERV - VISTA UNIT ASSEMBLY
D113722	VISTA SEL - MODE PROGRAMMER
P111442	BBV - BATTERY-POWERED PANIC DEVICE
P111445	SBV - ANODIZED SUPPORTING BEAM FOR LINEA
P111404	SEAGLE 2 - BI-DIRECTIONAL MICROWAVE RADAR
P111403	EAGLE 1 - MONO- AND BI-DIRECTIONAL MICROWAVE RADAR
P111402 00001	ACTIVE 8 - MICROWAVE RADAR WITH IR SAFETY CURTAINS
P111406	SPOTFINDER - INFRARED DETECTOR
P111405	REMOTE CONTROL
P111325	RIP - INFRARED RADAR
P111265	FPA1 - PHOTOCCELL MANAGEMENT SYSTEM WITH 1 PAIR OF SENSORS
P111266	FPA1 - PHOTOCCELL MANAGEMENT SYSTEM WITH 2 PAIRS OF SENSORS
N999305	MOBILE LEAF SEALING BRUSH PACK

ASSEMBLY KITS

Assembly kits	
Aluminium profile kits	
Belt	
Wiring kits	

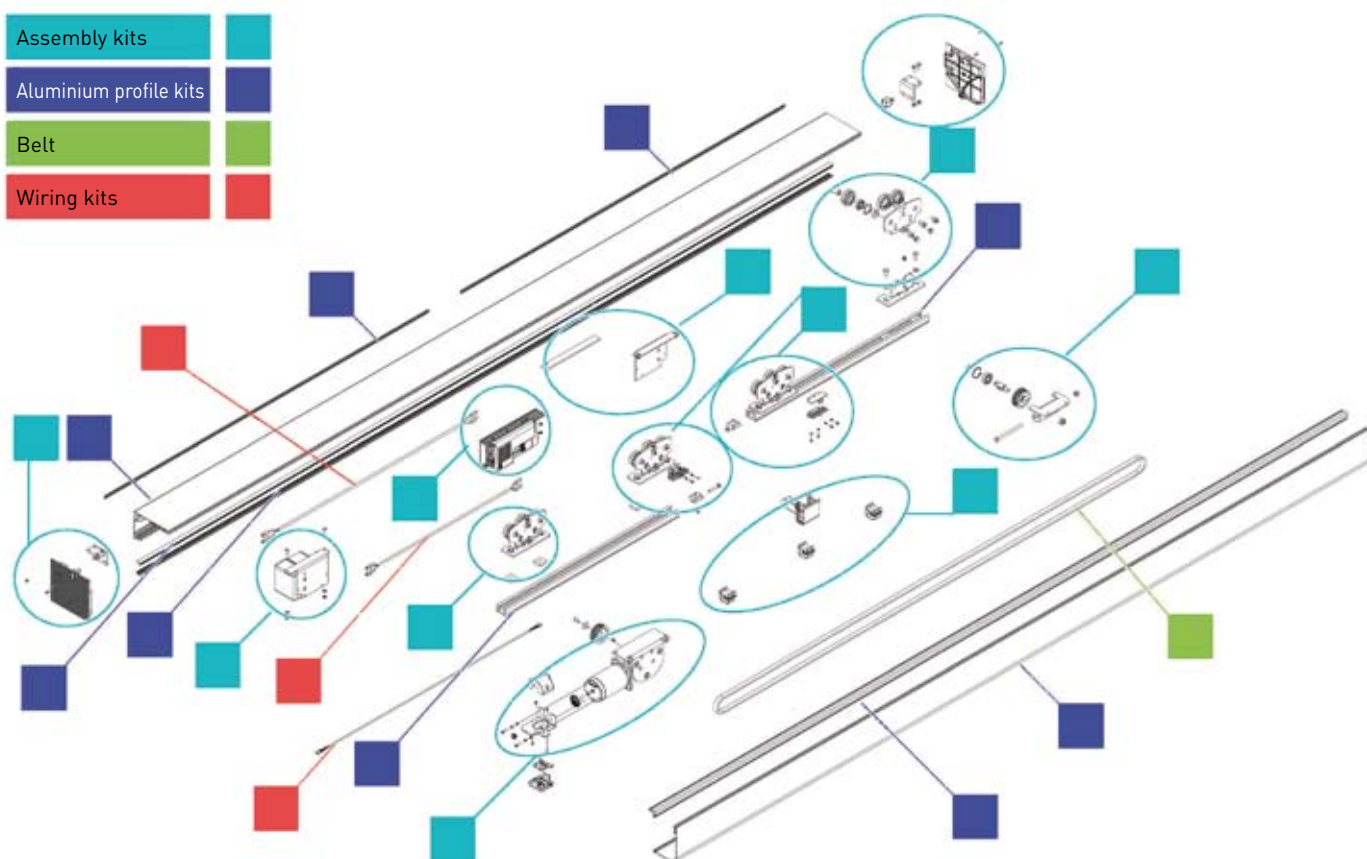

CODE	DESCRIPTION
P960536 00002	230V 2-LEAF VISTA2 ASSEMBLY KIT
P960535 00002	230V 1-LEAF VISTA1 ASSEMBLY KIT
P960533 00002	ANOD. ALUMINIUM PROFILE KIT, 4.2 M LONG
P960534 00002	ANOD. ALUMINIUM PROFILE KIT, 6.5 M LONG
P960533 00001	NATURAL. ALUMINIUM PROFILE KIT, 4.2 M LONG
P960534 00001	NATURAL. ALUMINIUM PROFILE KIT, 6.5 M LONG
P111447	WIRING KIT VISTA SL MOD 107-125 E 212-229
P111448	WIRING KIT VISTA SL MOD 208-211
D191099	VISTA SL BELT KIT- 30 MT PACK

COMPONENTS AND ACCESSORIES



SASAM1 - SASAM 2

Breakout door device enabling door leaves to be pushed open even when the door is closed. Complete with safety contacts that prevent the door from being driven by the motor when door leaves are "

SASAM-1 designed for use with single-leaf doors (maximum opening width 1100mm)

SASAM-2 designed for use with two-leaf doors (maximum opening width 2200mm)

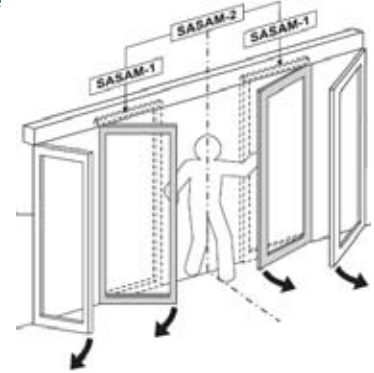

PPA
Aluminium clamp for tempered glass doors with no frame

MODEL	mm	CODE
MOD. 107	10	P111159 00001
	12	P111159 00063
MOD. 108	10	P111159 00002
	12	P111159 00064
MOD. 109	10	P111159 00003
	12	P111159 00065
MOD. 110	10	P111159 00004
	12	P111159 00066
MOD. 111	10	P111159 00005
	12	P111159 00067
MOD. 112	10	P111159 00006
	12	P111159 00068

MODEL	mm	CODE
MOD. 113	10	P111159 00007
	12	P111159 00069
MOD. 114	10	P111159 00008
	12	P111159 00070
MOD. 115	10	P111159 00009
	12	P111159 00071
MOD. 116	10	P111159 00010
	12	P111159 00072
MOD. 117	10	P111159 00011
	12	P111159 00073
MOD. 119	10	P111159 00012
	12	P111159 00074
MOD. 121	10	P111159 00013
	12	P111159 00075
MOD. 123	10	P111159 00014
	12	P111159 00076
MOD. 125	10	P111159 00015
	12	P111159 00077
MOD. 208	10	P111159 00016
	12	P111159 00078
MOD. 109	10	P111159 00017
	12	P111159 00079
MOD. 210	10	P111159 00018
	12	P111159 00080
MOD. 211	10	P111159 00019
	12	P111159 00081

MODEL	mm	CODE
MOD. 212	10	P111159 00020
	12	P111159 00082
MOD. 213	10	P111159 00021
	12	P111159 00083
MOD. 214	10	P111159 00022
	12	P111159 00084
MOD. 215	10	P111159 00023
	12	P111159 00085
MOD. 216	10	P111159 00024
	12	P111159 00086
MOD. 217	10	P111159 00025
	12	P111159 00087
MOD. 219	10	P111159 00026
	12	P111159 00088
MOD. 221	10	P111159 00027
	12	P111159 00089
MOD. 223	10	P111159 00028
	12	P111159 00090
MOD. 225	10	P111159 00029
	12	P111159 00091
MOD. 227	10	P111159 00030
	12	P111159 00092
MOD. 209	10	P111159 00031
	12	P111159 00093

PROFILES

ASSEMBLY OF FIXED DOOR SYSTEM

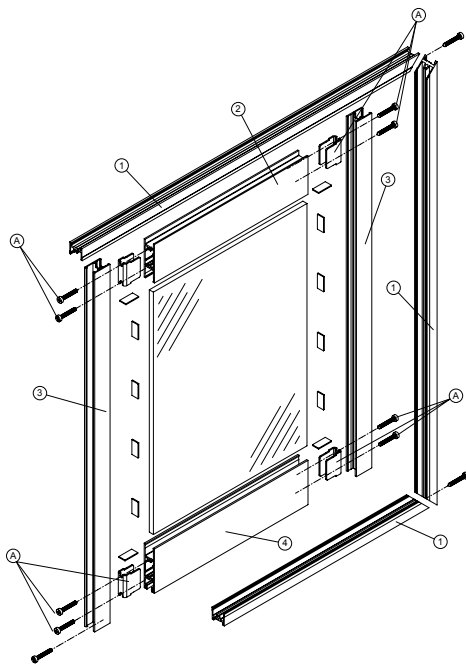

ASSEMBLY AND INSTALLATION OF SLIDING DOOR

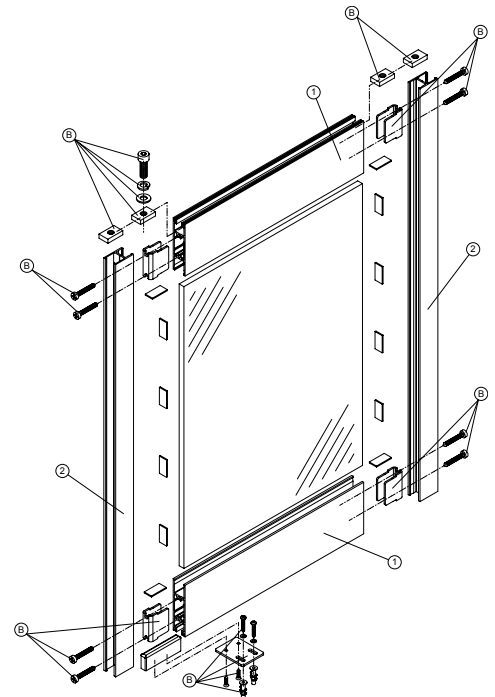

ASSEMBLY OF DOUBLE FIXED DOOR SYSTEM

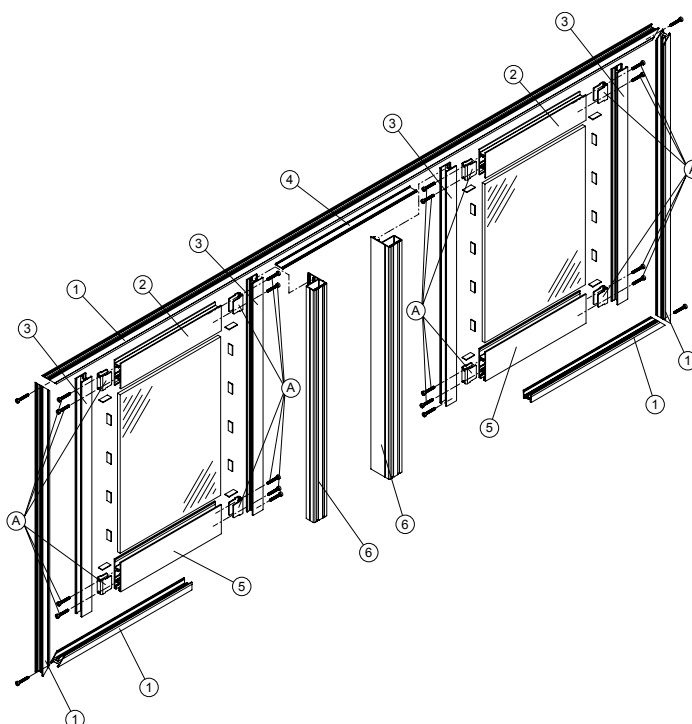

NOTES

- Channel sections are supplied in 5m lengths and weatherstripping in 30m rolls.
- The 20 mm contours are not suitable with the SASAM antipanic system.
- The 20 mm contours are available also painted upon request.
- The profiles are available in assembly kits. Call BFT for more information.

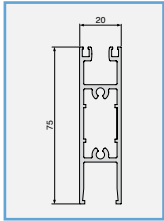

Top profile for bottom mobile leaf, fixed and mobile leaf.

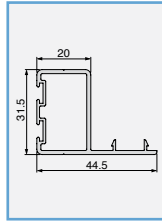

Edge profile / photocell holder.

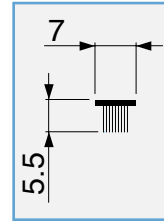

Side sealing brush pack.

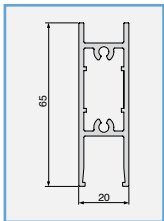

Top profile for fixed leaf.

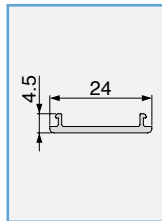

Latch profile.

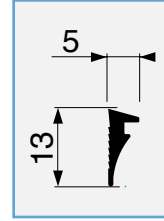

Glass stopper seal pack.

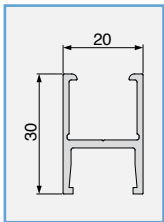

Jamb profile.

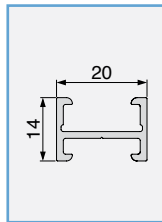

Weather strip profile.

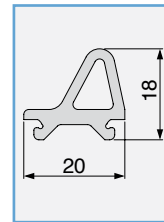

Leaf latch seal pack.

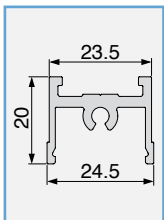

Frame profile.

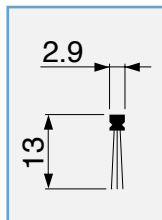

Mobile leaf sealing brush pack.

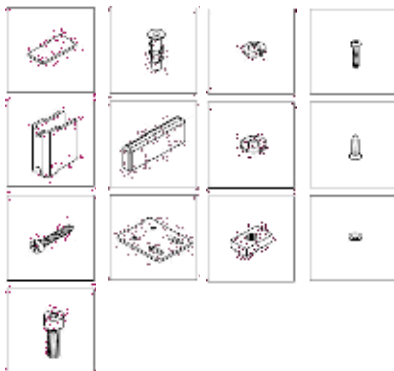

Accessory pack for assembling 1 mobile leaf. See drawing (B)



Accessory pack for constructing 1 fixed leaf. See drawing (A)

EAGLE ONE - SEAGLE TWO MICROWAVE PRESENCE DETECTORS



Example of installation

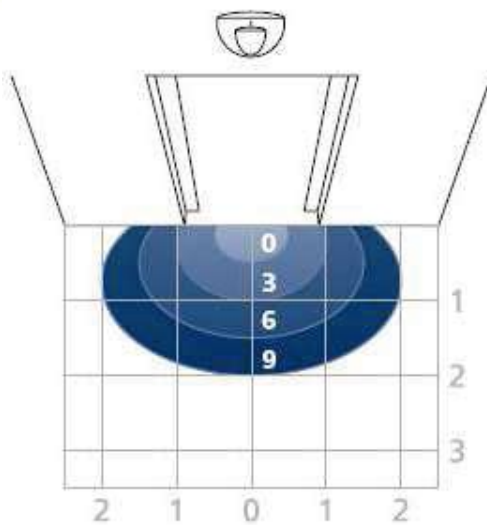

Detection range based on sensitivity adjustment

- Mono- and/or bi-directional detector
- Universal motion detector for automatic doors with high energy efficiency .
- K-band planar antenna specifically designed for automatic doors
- Digital electronics controlled by a powerful microprocessor
- Very wide detection lobe to provide the user with the best possible comfort and good side motion detection on approach
- "3D" adjustment: the antenna can be rotated along both axes:
- Front adjustment: from 0° to 90°
- Side adjustment: from 30° on left to 30° on right!
- Can be fitted as high up as 4 m (up to 3 metres for SEAGLE TWO)
- Strong ABS casing
- Programming via REMOTE CONTROL (for EAGLE only)



TELECOMANDO

Instrument employed to program the EAGLE sensor by adjusting:

- Sensitivity
- Programming mode
- Immunity
- Relay output configuration

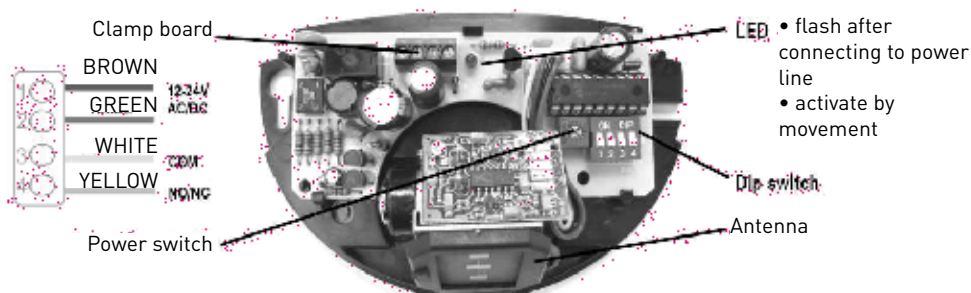

Structure, connection and adjustment

ACTIVE8 TWO PB - COMBINED MICROWAVE-INFRARED DETECTOR

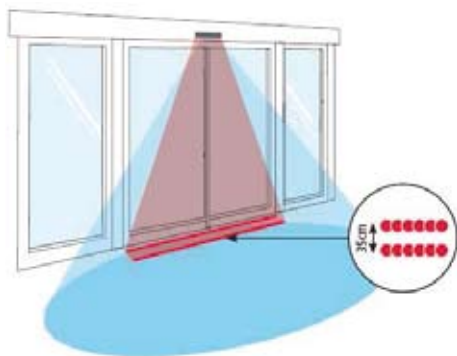

Example of installation



- Hyperfrequency and active infrared combined in a single unit
- Numerical electronics
- Motion detection for one-way opening (detection on approach)
- Presence detection provided by a double IR curtain, each comprising 24 interlaced spots so as to assure even, reliable detection
- Simplified settings courtesy of pre-programmed configurations

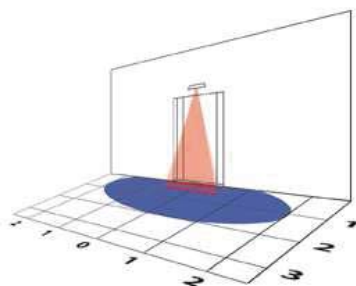
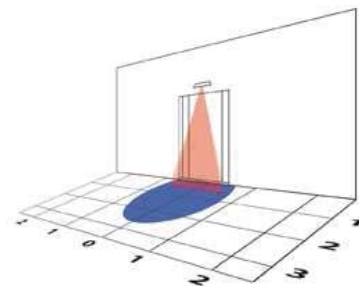
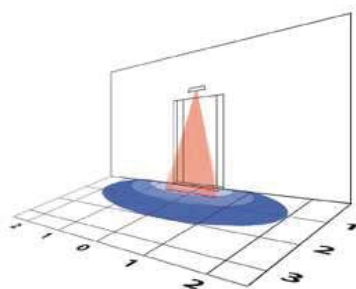

Detection ranges that can be achieved based on sensitivity settings, tilt and antenna type.

SPOTFINDER

- Instrument used to detect the exact position of the infrared safety curtains



Structure, connections and adjustment

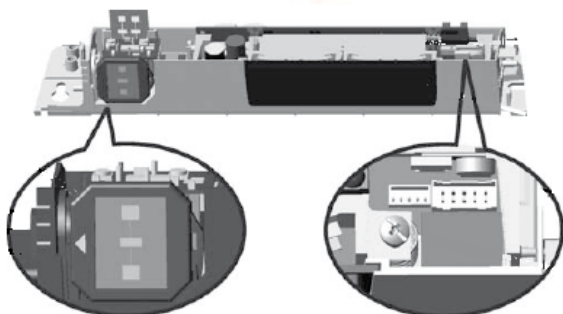

RIP - FPA - INFRARED AND PHOTOCELL PRESENCE DETECTORS

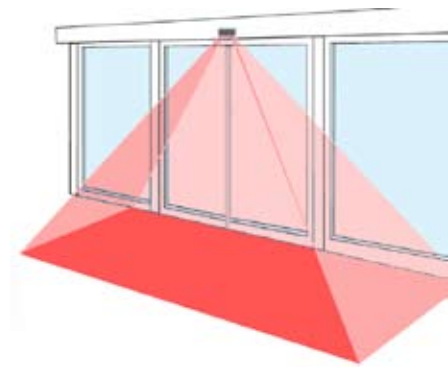

Example of installation

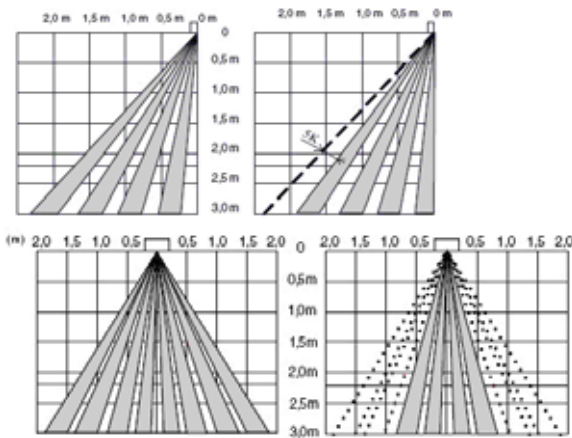

Detection ranges based on adjustments

RIP

- Infrared presence detector
- Installation height up to 3 metres
- Double changeover output contact (NO/NC)
- Snow mode management
- Work frequency setting so that a number of sensors can be used close to each other without interference



FPA 1 - FPA 2

- Recessed safety photocells for automatic pedestrian doors
- Safe, accurate operation by virtue of "microprocessor" technology
- Extremely small optics (12.4 mm in diam and 10 mm deep) for "concealed" install
- Maximum range up to 10 metres
- Double output contact (NO/NC)

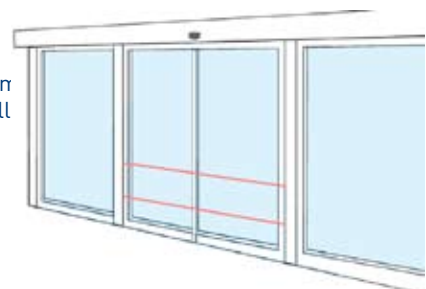

Example of installation

SPECIFICATIONS

VISTA SL

Electromechanical automation for sliding doors

- with double and/or single leaf
- maximum weight 120+120 kg for double leaf
- maximum weight 150 kg for single leaf
- door opening width in range 750 to 2550 mm for single leaf
- door opening width in range 800 to 2900 mm for double leaf

Structure

- load-bearing header in extruded aluminium
- maximum overall dimensions 155x166mm
- shaped extruded aluminium cover fitted on shock-absorbing rubber hinge. Comes in natural or anodized
- galvanized steel cover locking lever with double locking position
- extruded aluminium track fitted on shock-absorbing bearing
- driven pulley with belt tensioning system and safety lock

Drive

- 24Vac synchronous motor with built-in optical encoder
- electric system stopping door opening motion

Management and control unit

- microprocessor-based control unit ARIA
- programming via display and buttons

- mode selection via VISTA SEL
- digital selector 433Mhz rolling-code radio-receiver supplied as standard

Main settable functions

- Automatic closing (0-60 sec)
- Time-to-clear (1-99 sec)
- Partial opening (10-70%)
- Partial lock opening (3-30 cm)
- Alarm time (1-90 sec)
- Acceleration (1-10)
- Brake (1-10)
- Opening deceleration distance (10-70 cm)
- Closing deceleration distance (10-70 cm)
- Opening slow-down distance (10-20 cm)
- Closing slow-down distance (10-20 cm)
- Opening speed (1-99%)
- Closing speed (1-99%)
- Opening torque (1-99%)
- Closing torque (1-99%)
- Zones (0-127)
- Door mode (0-6)
- Radar enabling (0-2)
- Emergency input (0-3)
- Buzzer (0-3)
- Lock type (0-5)
- Door alarm output (0-1)

Automatically set functions

- Acceleration
- Brake
- Opening deceleration distance
- Closing deceleration distance
- Opening slow-down distance
- Closing slow-down distance
- Opening speed

- Closing speed
- Opening torque
- Closing torque
- Safety operation testing

Available modes

- Programming unrestricted or protected by magnetic key
- Activate internal radar
- Activate external radar
- Activate internal and external radars
- Deactivate radar
- Normal mode
- Door closed at night
- Door closed by day
- Total opening
- Partial opening
- Partial open
- Partial lock opening

Safety devices

- electronic management of anti-crush feature
- dynamic monitoring of torque curve
- encoder-managed electronic anti-burglary system

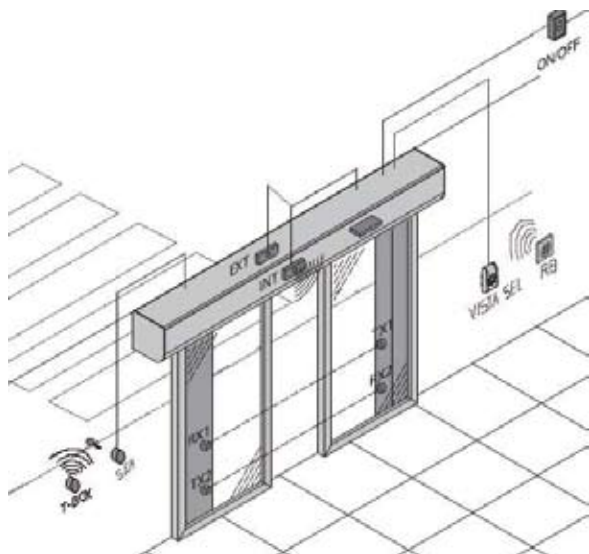

EXAMPLE OF A COMPLETE SYSTEM

- VISTA SL automatic sliding door
- VISTA SEL mode selector
- SEK reinforced key switch for exterior use
- T-BOX wireless numerical keypad
- RB 4-channel wireless wall button
- EXT - INT pair of presence detectors
- TX - RX safety photocells



ITALIA

BFT S.P.A.

Via Lago di Vico 44
36015 Schio (Vi) / Italy
tel. +39 0445 69 65 11
fax +39 0445 69 65 22
www.bft.it
e-mail: info@bft.it

GREAT BRITAIN

BFT AUTOMATION UK LTD

Unit 8E, Newby Road
Industrial Estate
Hazel Grove, Stockport,
Cheshire, SK7 5DA - UK
tel. +44 (0) 161 4560456
fax +44 (0) 161 4569090
info@bftautomation.co.uk
www.bftautomation.co.uk

FRANCE

AUTOMATISMES BFT FRANCE

Multiparc de Parilly
50 Rue Jean Zay, Bat C
69800 Saint priest - France
tel. +33 (0)4 78 76 09 88
fax +33 (0)4 78 76 92 23
contacts@automatismes-bft-
www.bft-france.com

GERMANY

BFT TORANTRIEBSSYSTEME GMBH

Faber-Castell-Straße 29
90522 Oberasbach - Germany
Tel. +49 (0)911 766 00 90
Fax +49 (0)911 766 00 99
service@bft-torantriebe.de
www.bft-torantriebe.de

CROATIA

BFT-ADRIA d.o.o.

Obrovac 39
51218 Dražice (Rijeka)
Hrvatska - Croatia
tel. +385 (0)51 502 640
fax +385 (0)51 502 644
info@bft.hr
www.bft.hr

USA

BFT USA

BFT U.S., Inc.
6100 Broken Sound Pkwy. N.W.
Suite 14
Boca Raton, FL 33487,
U.S.A.
T: +1 561.995.8155
F: +1 561.995.8160
info.bft@bft-usa.com
www.bft-usa.com

PORTUGAL

BFT SA-COMERCIO DE AUTOMATISMOS E MATERIAL DE SEGURANÇA

urbanização da pedrulha, lote 9
apartado 8123,
3020-305 Coimbra - Portugal
tel. +351 239 082 790
fax +351 239 082 799
geral@bftportugal.com
www.bftportugal.com

SPAIN

BFT GROUP ITALIBERICA DE AUTOMATISMOS S.L.

Pol. Palou Nord,
Sector F - C/Cami - Can Basa nº 6-8
08401 Granollers - (Barcelona) - Spain
tel. +34 938 61 48 28
fax +34 938 70 03 94
bftbcn@bftautomatismos.com

P.I. Comendador - C/
informática, Nave 22 - 19200
Azuqueca de henares
(Guadalajara) - Spain
tel. +34 949 26 32 00
fax +34 949 26 24 51
administracion@bftautomatismos.com

POLAND

BFT Polska Sp.z o.o.

Ul. Lipowa 21
05-091 ZĄBKI
tel. +48 0 22 781 60 55
fax +48 0 22 781 60 22
e-mail: biuro@bft.com.pl
www.bft.pl

BELGIUM

BFT BENELUX SA

Parc Industriel 1
Rue du commerce 12
1400 Nivelles - Belgium
tel. +32 (0)67 55 02 00
fax +32 (0)67 55 02 01
info@bftbenelux.be
www.bftbenelux.be

AUSTRALIA

BFT AUTOMATION AUSTRALIA PTY LTD

29, Bentley Street
Wetherill Park NSW 2164
Australia
Tel: +61 (0) 2 9757 0677
Fax: +61 (0) 2 9725 4225
info@bftaustralia.com.au
www.bftaustralia.com.au